



REYNAERS®

— at home —



CF68



Bi-fold doors, or folding sliding doors if you prefer, are a modern and innovative design statement that can transform an ordinary room and make it a feature of the house. These doors can flood the room with natural daylight and open up the house to the garden, letting the outside in.

Bi-fold doors have been hugely popular in the UK for a number of years. The Reynaers at Home CF68, as a new addition to the Reynaers product range, benefits from years of experience, research and development. The result is a stylish looking product that combines industry-leading performance with smooth and reliable operation.

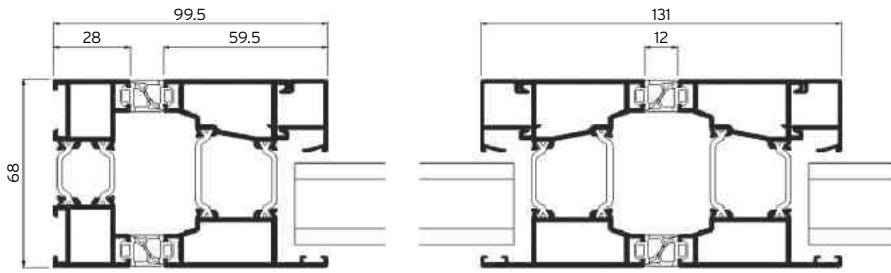

Versatile design options

Available in a number of configurations using between 2 and 7 door leaves, you can specify a design where all the door leaves stack to the same side, or a design where some stack one way and some the other. Choose whether you want the doors to open in or out, and remember that designs with a single traffic door enable you to slip quickly and easily into the garden, while leaving the other doors in place.



Technical Characteristics					
Variants		Flush threshold	Low threshold	Double Weather Seal	High performance
Visible width/height	Frame/Threshold	0-15 mm	9-30 mm	23-44 mm	23-74 mm
	Frame-vent section	100 mm			
	Vent-vent section	131 mm			
Overall system depth		68 mm			
Maximum element height		2500 mm			
Maximum vent weight		90 kg			
Rebate height		14 mm			
Glass thickness		12-55 mm			
Glazing method		dry glazing with EPDM or neutral silicones			
Thermal insulation		23 mm, 27.5 mm and 32 mm fibreglass reinforced polyamide strips			
HI variant		extra insulation foams			

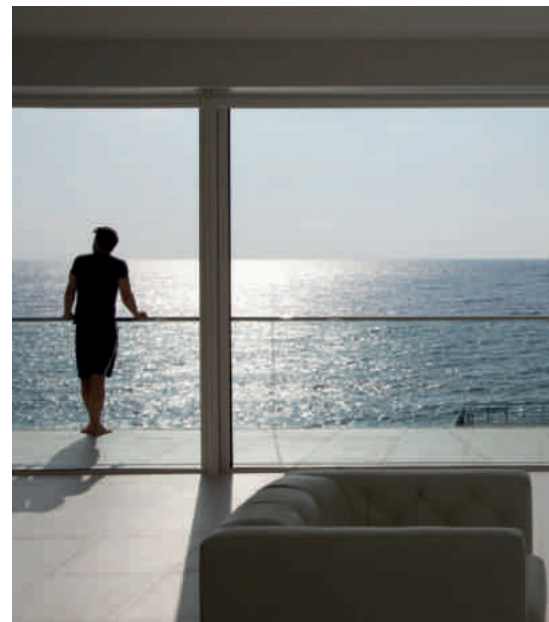

Innovative features and benefits

- Great thermal insulation down to 1.1W/m²K
- Glazing thickness up to 55mm
- Security to British and European standards including Secured by Design
- Inward or outward opening
- Four threshold options
- Water resistance up to 600Pa
- 2 to 7 door leaves
- Maximum height 2500mm
- Maximum door leaf width 1000mm
- High spec stainless steel rollers









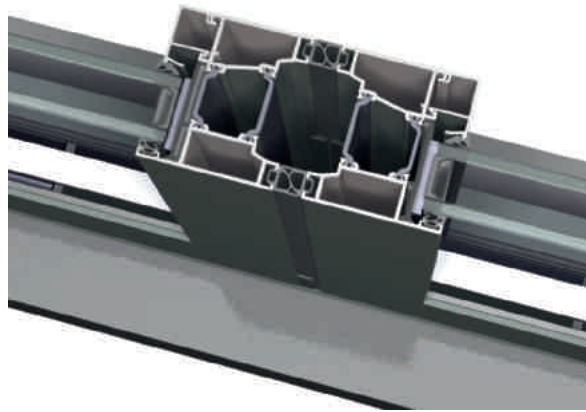

Threshold options

The CF68 can be specified with any of four different threshold options

- High performance
- Double weather seal
- Low threshold
- Flat bottom

Each threshold option gives a trade-off between weather performance and ease of passage. The High Performance option offers the best air, wind and water performance but has the highest threshold step. The double weather-seal solution combines good weather resistance with a lower threshold. The low threshold option can be set into the floor to meet the requirements of building regulations, and the flat bottom solution allows easy passage with no step at all, but this is at the expense of weather-proofing.



Performances					
		Flush threshold	Low threshold	Double weather seal	High performance
	Energy				
	Thermal Insulation ⁽¹⁾ EN ISO 10077-2	Uf-value down to 1.8 W/m ² K (*), depending on the profile combination.			
	Comfort				
	Air tightness, max. test pressure ⁽²⁾ EN 12207	Not applicable	Class 4	Class 4	Class 4
	Water tightness ⁽³⁾ EN 12208	Not applicable	Class 5a (200 Pa)	Class 7a (300 Pa)	Up to Class 9a (600 Pa)
	Wind load resistance ⁽⁴⁾ EN 12211; EN 12210	Not applicable	C1/B3	C2/B3	C2/B3
	Safety				
	Burglar resistance ⁽⁵⁾ ENV 1627 - ENV 1630	Not applicable	RC2	RC2	RC2

This table shows classes and values of performance, which can be achieved for specific configurations and opening types.

- (1) The Ud value measures the heat flow. The lower the Ud value, the better the thermal performance of the door
- (2) The air tightness test measures the volume of air that would pass through a closed door at a certain air pressure
- (3) The water tightness test involves applying a uniform water spray at increasing air pressure until water penetrates the door
- (4) The wind load resistance test is a measure of the profile's structural strength and involves applying increasing levels of air pressure to simulate wind force
- (5) The burglar resistance is tested using static and dynamic loads, as well as simulated attempts to break in using specified tools. This variant requires specific burglar resistant accessories
- (6) Please refer to Reynaers' CE passport for all technical data including size limitations
- (*) Value for HI-variant



Reynaers at Home · Kettles Wood Drive · Birmingham · B32 3DB

T 0121 421 9707 E homeuk@reynaers.com

www.reynaersathome.co.uk

Part of the Reynaers family

